

Wire end sleeve insulated twin 0.75 mm² - 8 mm A00752TWIN

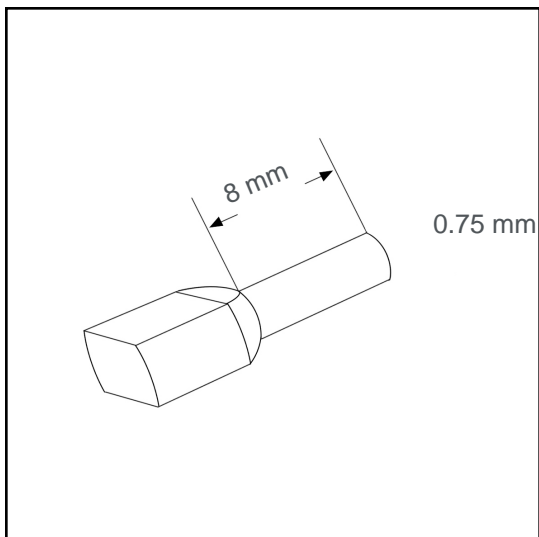

Datasheet:

Cross section (mm ²):	0.75
AWG:	2x18
Length (mm):	8
Color:	light blue
Material:	Cu-DHP / Polypropylene
Surface:	tin plated
Minimum thickness of tin coating:	3 μm
Max. Temp:	105°C
REACH/RoHS:	confirmed
Certificates:	UL

for two wires in one ferrule

Packing sizes:

500 pcs.:	Part no.: 005654
10 x 100 pcs.:	Part no.: 005653
50000 pcs.:	Part no.: 005245

Dimensions (mm):

l1	l2	d1	s1	d2	s2	d3
15	8	1.73	0.15	2.6	0.3	5.4

