

Wire end sleeve insulated 1 mm² - 8 mm A01057GB

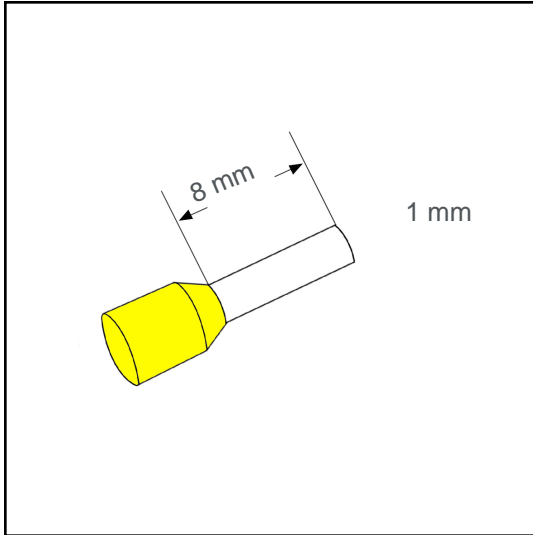

Datasheet:

Cross section (mm ²):	1
AWG:	18
Length (mm):	8
Color:	yellow
Material:	Cu-DHP / Polypropylene
Surface:	tin plated
Minimum thickness of tin coating:	3 μm
Max. Temp:	105°C
REACH/RoHS:	confirmed
Certificates:	UL

for wires with thick insulation (GB)

Packing sizes:

500 pcs.:	Part no.: 005729
10 x 100 pcs.:	Part no.: 005728
50000 pcs.:	Part no.: 005365

Dimensions (mm):

l1	l2	d1	s1	d2	s2
14	8	1.45	0.15	3.4	0.3

