

Wire end sleeve insulated 0.75 mm² - 8 mm A00752GB

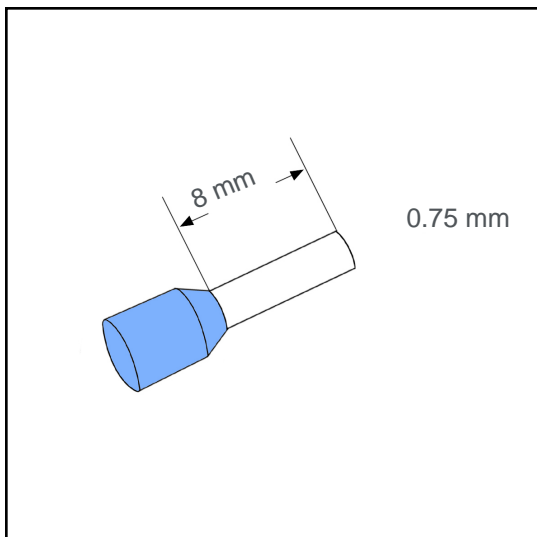

Datasheet:

Cross section (mm ²):	0.75
AWG:	18
Length (mm):	8
Color:	light blue
Material:	Cu-DHP / Polypropylene
Surface:	tin plated
Minimum thickness of tin coating:	3 μm
Max. Temp:	105°C
REACH/RoHS:	confirmed
Certificates:	UL

for wires with thick insulation (GB)

Packing sizes:

500 pcs.:	Part no.: 005648
10 x 100 pcs.:	Part no.: 005647
50000 pcs.:	Part no.: 005357

Dimensions (mm):

l1	l2	d1	s1	d2	s2
14.5	8	1.3	0.15	3.3	0.3

