

Wire end sleeve insulated 0.5 mm² - 10 mm A00575GB

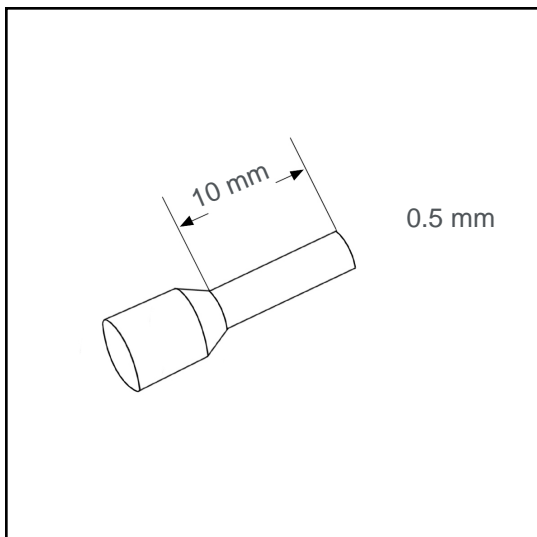

Datasheet:

Cross section (mm ²):	0.5
AWG:	20
Length (mm):	10
Color:	white
Material:	Cu-DHP / Polypropylene
Surface:	tin plated
Minimum thickness of tin coating:	3 μm
Max. Temp:	105°C
REACH/RoHS:	confirmed
Certificates:	UL

for wires with thick insulation (GB)

Packing sizes:

500 pcs.:	Part no.: 005628
10 x 100 pcs.:	Part no.: 005627
50000 pcs.:	Part no.: 005356

Dimensions (mm):

l1	l2	d1	s1	d2	s2
16.5	10	1.1	0.15	2.9	0.3

