

Wire end sleeve uninsulated 95 mm² - 32 mm B95032

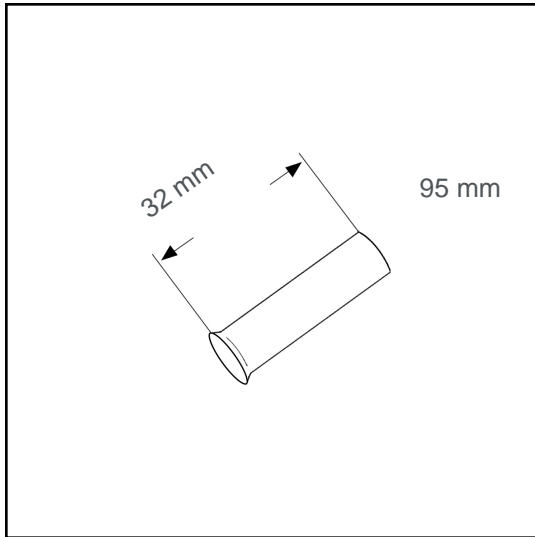

Datasheet:

Cross section (mm ²):	95
AWG:	3/0
Length (mm):	32
Material:	Cu-DHP
Surface:	tin plated
Minimum thickness of tin coating:	3 µm
Max. Temp:	105°C
REACH/RoHS:	confirmed

Packing sizes:

50 pcs.:	Part no.: 006111
500 pcs.:	Part no.: 005468

Dimensions (mm):

l1	d1	s1	d2
32	14.5	0.4	17

