

# Wire end sleeve uninsulated 95 mm<sup>2</sup> - 25 mm B95025

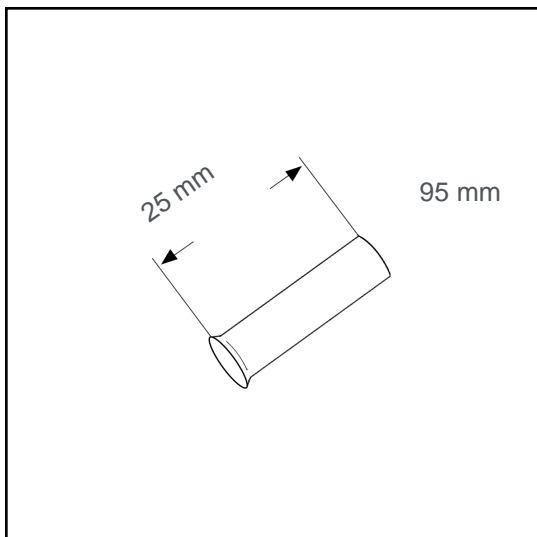

## Datasheet:

Cross section (mm <sup>2</sup> ):	95
AWG:	3/0
Length (mm):	25
Material:	Cu-DHP
Surface:	tin plated
Minimum thickness of tin coating:	3 µm
Max. Temp:	105°C
REACH/RoHS:	confirmed

## Packing sizes:

50 pcs.: Part no.: 006109

500 pcs.: Part no.: 005466

## Dimensions (mm):

l1	d1	s1	d2
25	14.5	0.4	17

