

# Wire end sleeve uninsulated 70 mm<sup>2</sup> - 40 mm B70040

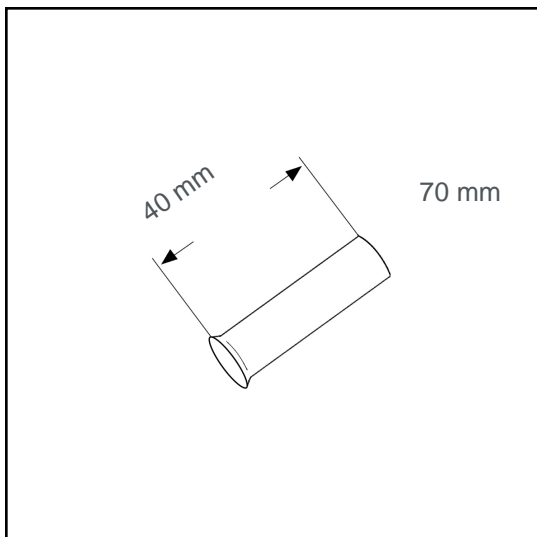

## Datasheet:

Cross section (mm <sup>2</sup> ):	70
AWG:	2/0
Length (mm):	40
Material:	Cu-DHP
Surface:	tin plated
Minimum thickness of tin coating:	3 µm
Max. Temp:	105°C
REACH/RoHS:	confirmed

## Packing sizes:

100 pcs.: Part no.: 006372

1000 pcs.: Part no.: 006367

## Dimensions (mm):

l1	d1	s1	d2
40	12.5	0.4	15

