

Wire end sleeve uninsulated 70 mm² - 25 mm B70025

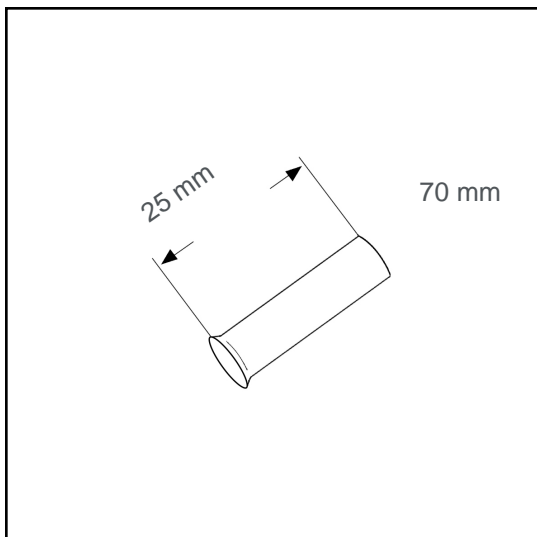

Datasheet:

Cross section (mm ²):	70
AWG:	2/0
Length (mm):	25
Material:	Cu-DHP
Surface:	tin plated
Minimum thickness of tin coating:	3 µm
Max. Temp:	105°C
REACH/RoHS:	confirmed

Packing sizes:

100 pcs.:	Part no.: 006107
1000 pcs.:	Part no.: 005464

Dimensions (mm):

l1	d1	s1	d2
25	12.5	0.4	15

