

Wire end sleeve uninsulated 50 mm² - 40 mm B50040

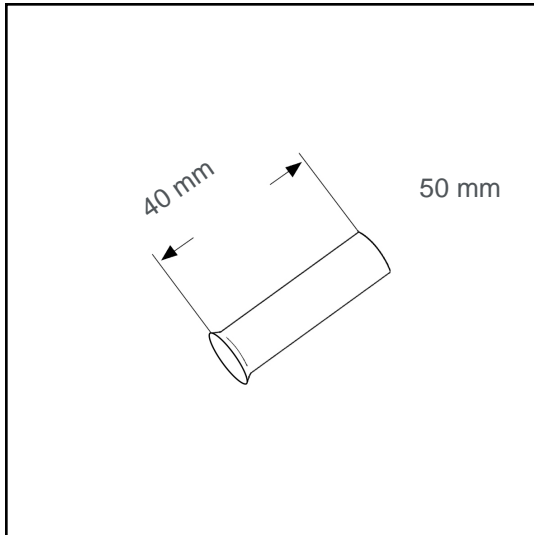

Datasheet:

Cross section (mm ²):	50
AWG:	1/0
Length (mm):	40
Material:	Cu-DHP
Surface:	tin plated
Minimum thickness of tin coating:	3 µm
Max. Temp:	105°C
REACH/RoHS:	confirmed

Packing sizes:

100 pcs.:	Part no.: 006371
5000 pcs.:	Part no.: 006366

Dimensions (mm):

l1	d1	s1	d2
40	10.3	0.3	13

