

# Wire end sleeve uninsulated 50 mm<sup>2</sup> - 18 mm B50018

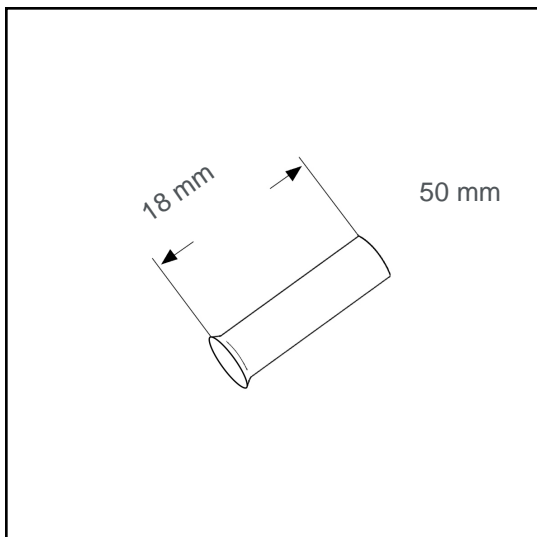

## Datasheet:

Cross section (mm <sup>2</sup> ):	50
AWG:	1/0
Length (mm):	18
Material:	Cu-DHP
Surface:	tin plated
Minimum thickness of tin coating:	3 µm
Max. Temp:	105°C
REACH/RoHS:	confirmed
Certificates:	UL
DIN:	DIN 46228 T1

## Packing sizes:

100 pcs.:	Part no.: 006102
5000 pcs.:	Part no.: 005459

## Dimensions (mm):

l1	d1	s1	d2
18	10.3	0.3	13

