

Wire end sleeve uninsulated 35 mm² - 18 mm B35018

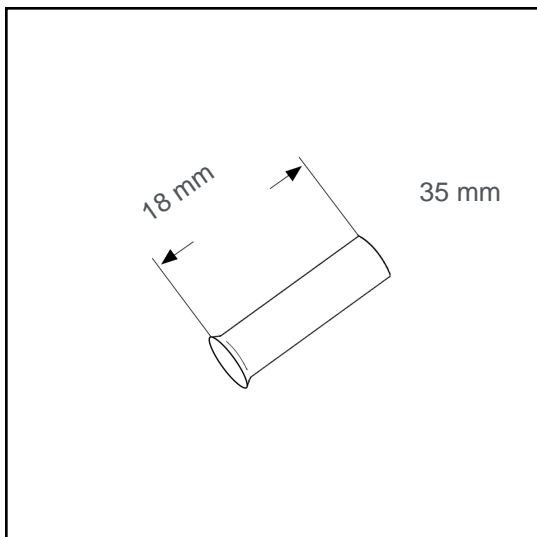

Datasheet:

Cross section (mm ²):	35
AWG:	2
Length (mm):	18
Material:	Cu-DHP
Surface:	tin plated
Minimum thickness of tin coating:	3 µm
Max. Temp:	105°C
REACH/RoHS:	confirmed
Certificates:	UL
DIN:	DIN 46228 T1

Packing sizes:

100 pcs.:	Part no.: 006098
10000 pcs.:	Part no.: 005455

Dimensions (mm):

l1	d1	s1	d2
18	8.3	0.2	11

