

Wire end sleeve uninsulated 25 mm² - 40 mm B25040

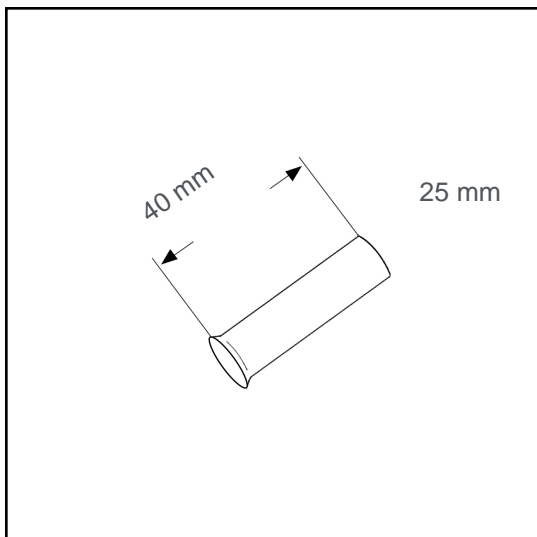

Datasheet:

Cross section (mm ²):	25
AWG:	4
Length (mm):	40
Material:	Cu-DHP
Surface:	tin plated
Minimum thickness of tin coating:	3 µm
Max. Temp:	105°C
REACH/RoHS:	confirmed

Packing sizes:

100 pcs.:	Part no.: 006369
10000 pcs.:	Part no.: 006364

Dimensions (mm):

l1	d1	s1	d2
40	7.3	0.2	9.5

