

Wire end sleeve uninsulated 25 mm² - 32 mm B25032

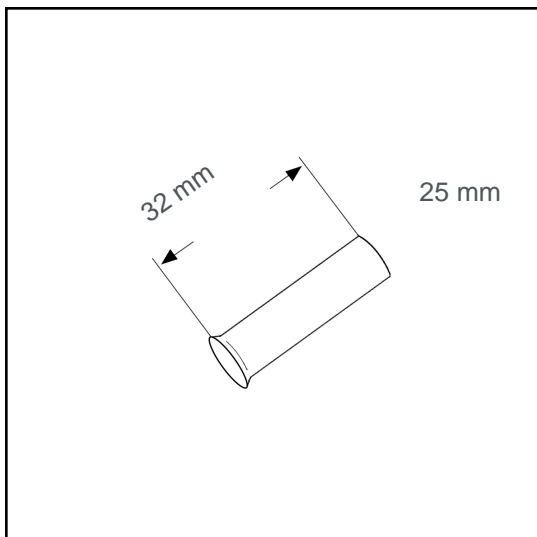

Datasheet:

Cross section (mm ²):	25
AWG:	4
Length (mm):	32
Material:	Cu-DHP
Surface:	tin plated
Minimum thickness of tin coating:	3 µm
Max. Temp:	105°C
REACH/RoHS:	confirmed
Certificates:	UL
DIN:	DIN 46228 T1

Packing sizes:

100 pcs.:	Part no.: 006095
10000 pcs.:	Part no.: 005452

Dimensions (mm):

l1	d1	s1	d2
32	7.3	0.2	9.5

