

Wire end sleeve uninsulated 25 mm² - 20 mm B25020

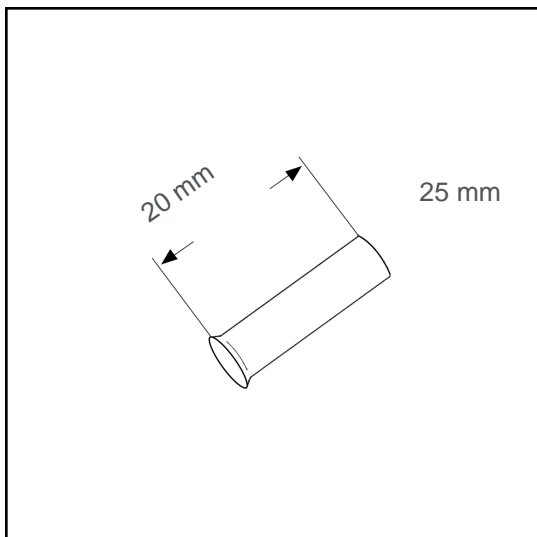

Datasheet:

Cross section (mm ²):	25
AWG:	4
Length (mm):	20
Material:	Cu-DHP
Surface:	tin plated
Minimum thickness of tin coating:	3 µm
Max. Temp:	105°C
REACH/RoHS:	confirmed

Packing sizes:

100 pcs.: Part no.: 006093

10000 pcs.: Part no.: 005450

Dimensions (mm):

l1	d1	s1	d2
20	7.3	0.2	9.5

