

# Wire end sleeve uninsulated 25 mm<sup>2</sup> - 15 mm B25015

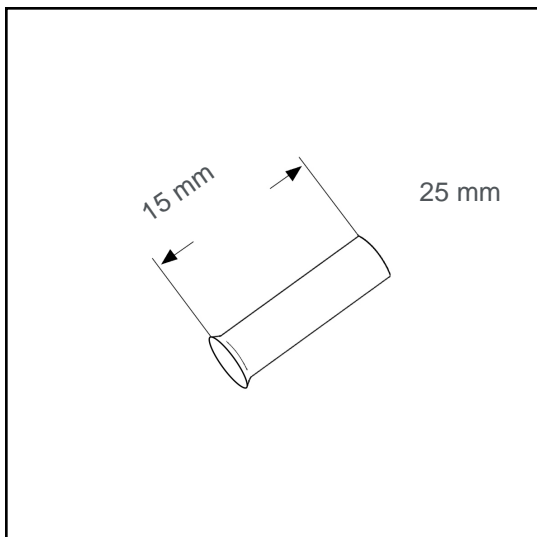

## Datasheet:

Cross section (mm <sup>2</sup> ):	25
AWG:	4
Length (mm):	15
Material:	Cu-DHP
Surface:	tin plated
Minimum thickness of tin coating:	3 µm
Max. Temp:	105°C
REACH/RoHS:	confirmed
Certificates:	UL
DIN:	DIN 46228 T1

## Packing sizes:

100 pcs.:	Part no.: 006091
10000 pcs.:	Part no.: 005448

## Dimensions (mm):

l1	d1	s1	d2
15	7.3	0.2	9.5

