

Wire end sleeve uninsulated 16 mm² - 20 mm B16020

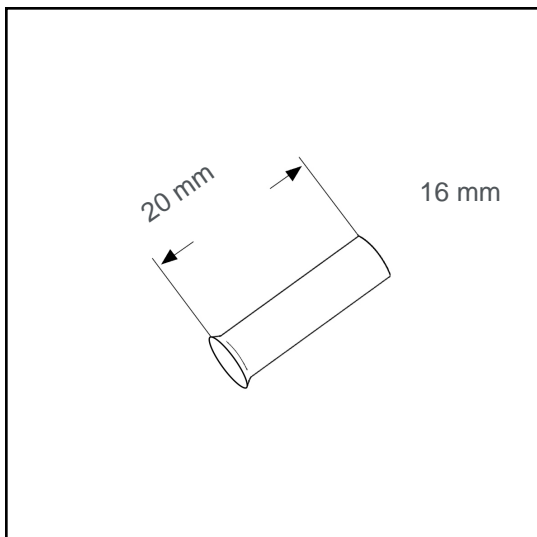

Datasheet:

Cross section (mm ²):	16
AWG:	6
Length (mm):	20
Material:	Cu-DHP
Surface:	tin plated
Minimum thickness of tin coating:	3 µm
Max. Temp:	105°C
REACH/RoHS:	confirmed

Packing sizes:

250 pcs.:	Part no.: 006083
10000 pcs.:	Part no.: 005441

Dimensions (mm):

l1	d1	s1	d2
20	5.8	0.2	7.5

