

Wire end sleeve uninsulated 150 mm² - 38 mm B150038

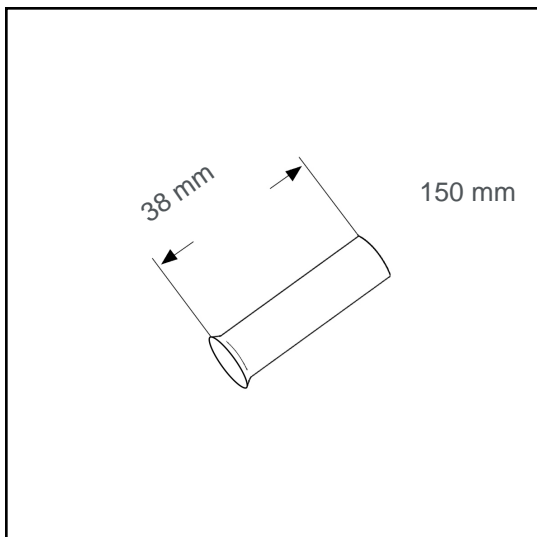

Datasheet:

Cross section (mm ²):	150
AWG:	300MCM
Length (mm):	38
Material:	Cu-DHP
Surface:	tin plated
Minimum thickness of tin coating:	3 µm
Max. Temp:	105°C
REACH/RoHS:	confirmed

Packing sizes:

50 pcs.:	Part no.: 006078
300 pcs.:	Part no.: 005437

Dimensions (mm):

l1	d1	s1	d2
38	18.5	0.5	21

