

Wire end sleeve uninsulated 150 mm² - 32 mm B150032

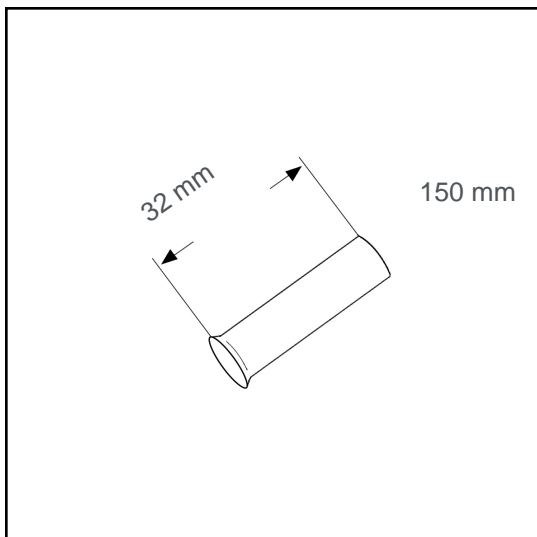

Datasheet:

Cross section (mm ²):	150
AWG:	300MCM
Length (mm):	32
Material:	Cu-DHP
Surface:	tin plated
Minimum thickness of tin coating:	3 µm
Max. Temp:	105°C
REACH/RoHS:	confirmed

Packing sizes:

50 pcs.:	Part no.: 006077
300 pcs.:	Part no.: 005436

Dimensions (mm):

l1	d1	s1	d2
32	18.5	0.5	21

