

Wire end sleeve uninsulated 10 mm² - 25 mm B10025

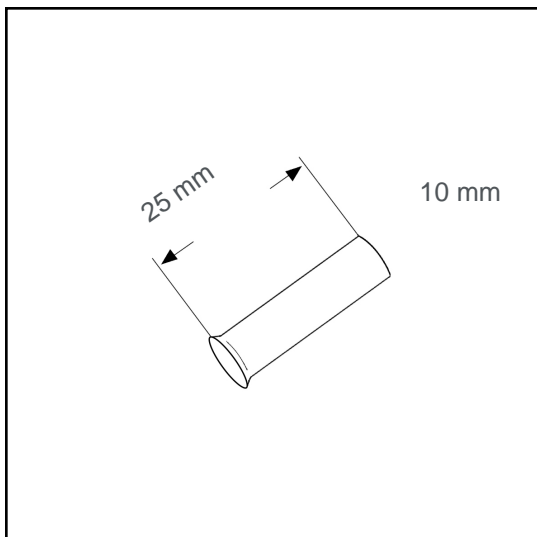

Datasheet:

Cross section (mm ²):	10
AWG:	8
Length (mm):	25
Material:	Cu-DHP
Surface:	tin plated
Minimum thickness of tin coating:	3 µm
Max. Temp:	105°C
REACH/RoHS:	confirmed

Packing sizes:

500 pcs.:	Part no.: 006074
15000 pcs.:	Part no.: 005433

Dimensions (mm):

l1	d1	s1	d2
25	4.5	0.2	5.8

