

Wire end sleeve uninsulated 10 mm² - 18 mm B10018

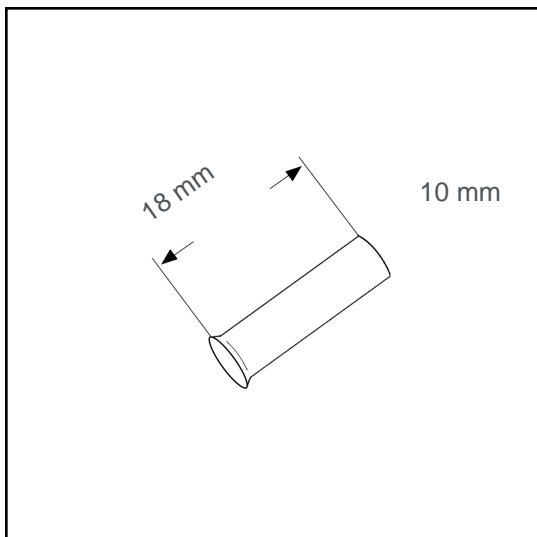

Datasheet:

Cross section (mm ²):	10
AWG:	8
Length (mm):	18
Material:	Cu-DHP
Surface:	tin plated
Minimum thickness of tin coating:	3 µm
Max. Temp:	105°C
REACH/RoHS:	confirmed
Certificates:	UL
DIN:	DIN 46228 T1

Packing sizes:

500 pcs.: Part no.: 006071

15000 pcs.: Part no.: 005431

Dimensions (mm):

l1	d1	s1	d2
18	4.5	0.2	5.8

