

Wire end sleeve uninsulated 6 mm² - 25 mm B06025

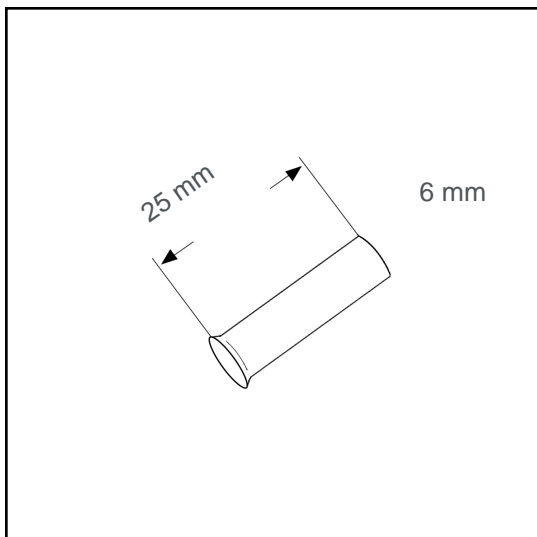

Datasheet:

Cross section (mm ²):	6
AWG:	10
Length (mm):	25
Material:	Cu-DHP
Surface:	tin plated
Minimum thickness of tin coating:	3 µm
Max. Temp:	105°C
REACH/RoHS:	confirmed

Packing sizes:

1000 pcs.:	Part no.: 006066
15000 pcs.:	Part no.: 005427

Dimensions (mm):

l1	d1	s1	d2
25	3.5	0.2	4.7

