

Wire end sleeve uninsulated 6 mm² - 15 mm B06015

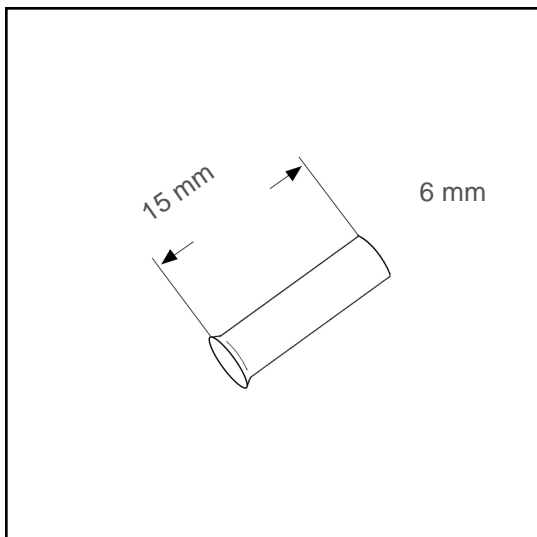

Datasheet:

Cross section (mm ²):	6
AWG:	10
Length (mm):	15
Material:	Cu-DHP
Surface:	tin plated
Minimum thickness of tin coating:	3 µm
Max. Temp:	105°C
REACH/RoHS:	confirmed
Certificates:	UL
DIN:	DIN 46228 T1

Packing sizes:

1000 pcs.:	Part no.: 006062
20000 pcs.:	Part no.: 005424

Dimensions (mm):

l1	d1	s1	d2
15	3.5	0.2	4.7

