

Wire end sleeve uninsulated 4 mm² - 18 mm B04018

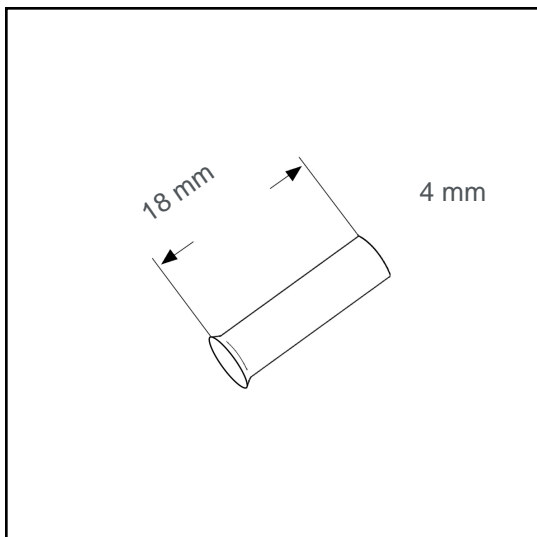

Datasheet:

Cross section (mm ²):	4
AWG:	12
Length (mm):	18
Material:	Cu-DHP
Surface:	tin plated
Minimum thickness of tin coating:	3 µm
Max. Temp:	105°C
REACH/RoHS:	confirmed
Certificates:	UL
DIN:	DIN 46228 T1

Packing sizes:

1000 pcs.:	Part no.: 006056
30000 pcs.:	Part no.: 005420

Dimensions (mm):

l1	d1	s1	d2
18	2.8	0.2	4

