

Wire end sleeve uninsulated 4 mm² - 15 mm B04015

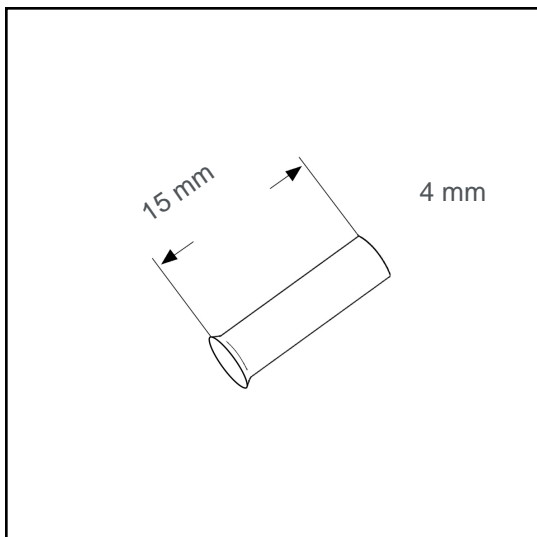

Datasheet:

Cross section (mm ²):	4
AWG:	12
Length (mm):	15
Material:	Cu-DHP
Surface:	tin plated
Minimum thickness of tin coating:	3 µm
Max. Temp:	105°C
REACH/RoHS:	confirmed
Certificates:	UL
DIN:	DIN 46228 T1

Packing sizes:

1000 pcs.:	Part no.: 006055
30000 pcs.:	Part no.: 005419

Dimensions (mm):

l1	d1	s1	d2
15	2.8	0.2	4

