

Wire end sleeve uninsulated 2.5 mm² - 15 mm B02515

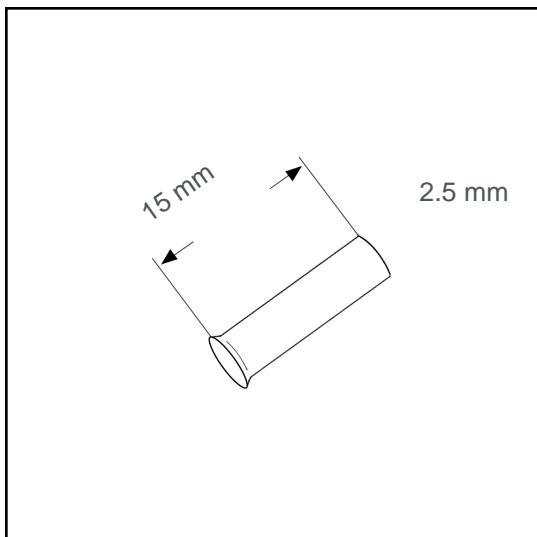

Datasheet:

Cross section (mm ²):	2.5
AWG:	14
Length (mm):	15
Material:	Cu-DHP
Surface:	tin plated
Minimum thickness of tin coating:	3 µm
Max. Temp:	105°C
REACH/RoHS:	confirmed

Packing sizes:

1000 pcs.:	Part no.: 006047
50000 pcs.:	Part no.: 005413

Dimensions (mm):

l1	d1	s1	d2
15	2.2	0.15	3.4

