

Wire end sleeve uninsulated 2.5 mm² - 8 mm B02508

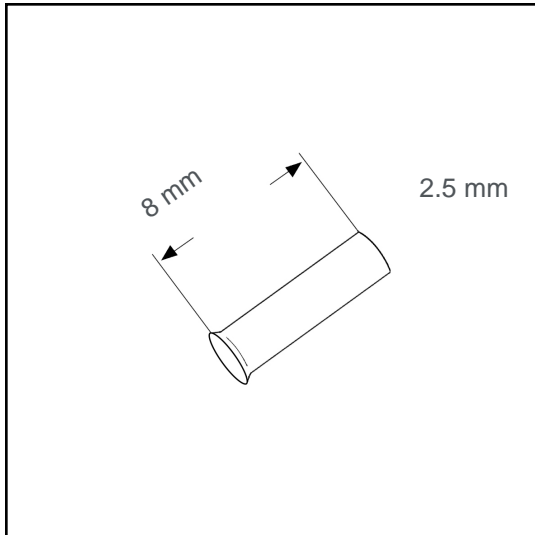

Datasheet:

Cross section (mm ²):	2.5
AWG:	14
Length (mm):	8
Material:	Cu-DHP
Surface:	tin plated
Minimum thickness of tin coating:	3 µm
Max. Temp:	105°C
REACH/RoHS:	confirmed

Packing sizes:

1000 pcs.: Part no.: 006042

50000 pcs.: Part no.: 005410

Dimensions (mm):

l1	d1	s1	d2
8	2.2	0.15	3.4

