

## Wire end sleeve uninsulated 2.5 mm<sup>2</sup> - 7 mm B02507

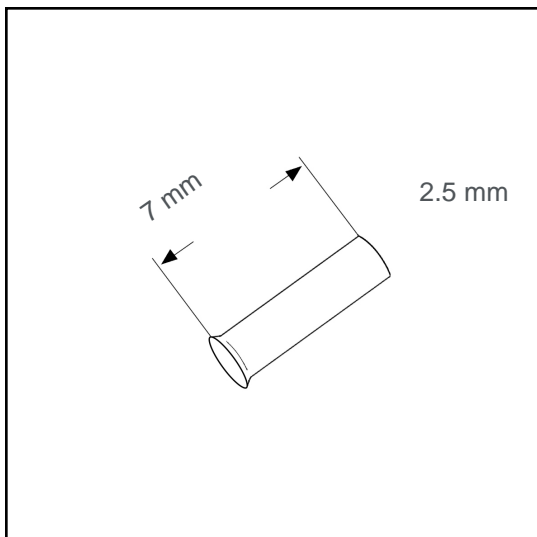

### Datasheet:

Cross section (mm <sup>2</sup> ):	2.5
AWG:	14
Length (mm):	7
Material:	Cu-DHP
Surface:	tin plated
Minimum thickness of tin coating:	3 µm
Max. Temp:	105°C
REACH/RoHS:	confirmed
Certificates:	UL
DIN:	DIN 46228 T1

### Packing sizes:

1000 pcs.:	Part no.: 006040
50000 pcs.:	Part no.: 005408

### Dimensions (mm):

l1	d1	s1	d2
7	2.2	0.15	3.4

