

Wire end sleeve uninsulated 1.5 mm² - 10 mm B01510

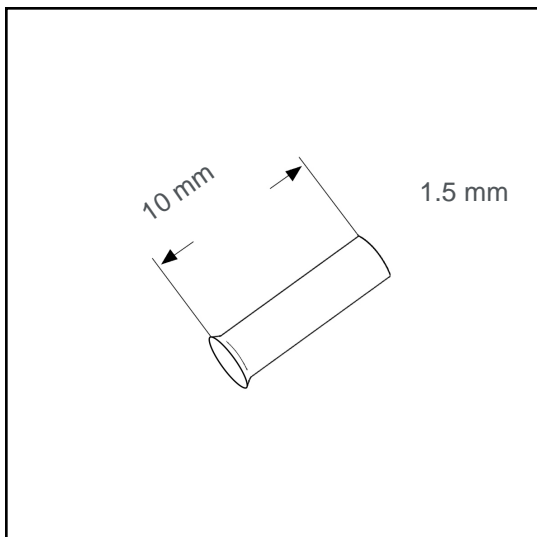

Datasheet:

Cross section (mm ²):	1.5
AWG:	16
Length (mm):	10
Material:	Cu-DHP
Surface:	tin plated
Minimum thickness of tin coating:	3 µm
Max. Temp:	105°C
REACH/RoHS:	confirmed
Certificates:	UL
DIN:	DIN 46228 T1

Packing sizes:

1000 pcs.:	Part no.: 006031
50000 pcs.:	Part no.: 005402

Dimensions (mm):

l1	d1	s1	d2
10	1.7	0.15	2.8

