

## Wire end sleeve uninsulated 1.5 mm<sup>2</sup> - 8 mm B01508

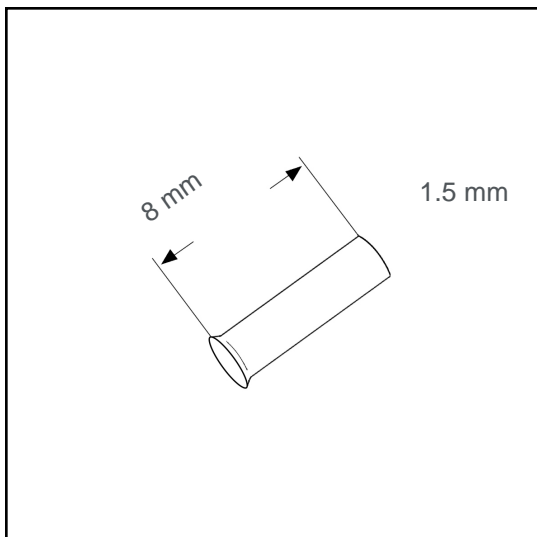

### Datasheet:

Cross section (mm <sup>2</sup> ):	1.5
AWG:	16
Length (mm):	8
Material:	Cu-DHP
Surface:	tin plated
Minimum thickness of tin coating:	3 µm
Max. Temp:	105°C
REACH/RoHS:	confirmed

### Packing sizes:

1000 pcs.:	Part no.: 006030
50000 pcs.:	Part no.: 005401

### Dimensions (mm):

l1	d1	s1	d2
8	1.7	0.15	2.8

