

Wire end sleeve uninsulated 1 mm² - 7 mm B01007

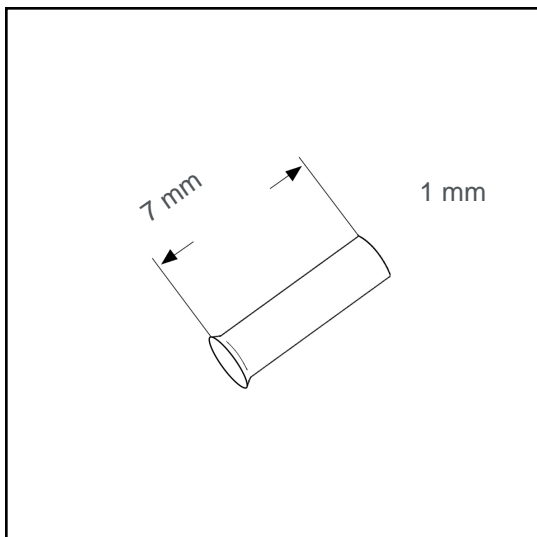

Datasheet:

Cross section (mm ²):	1
AWG:	18
Length (mm):	7
Material:	Cu-DHP
Surface:	tin plated
Minimum thickness of tin coating:	3 µm
Max. Temp:	105°C
REACH/RoHS:	confirmed

Packing sizes:

1000 pcs.:	Part no.: 006019
50000 pcs.:	Part no.: 005394

Dimensions (mm):

l1	d1	s1	d2
7	1.4	0.15	2.5

