

# Wire end sleeve uninsulated 1 mm<sup>2</sup> - 6 mm B01006

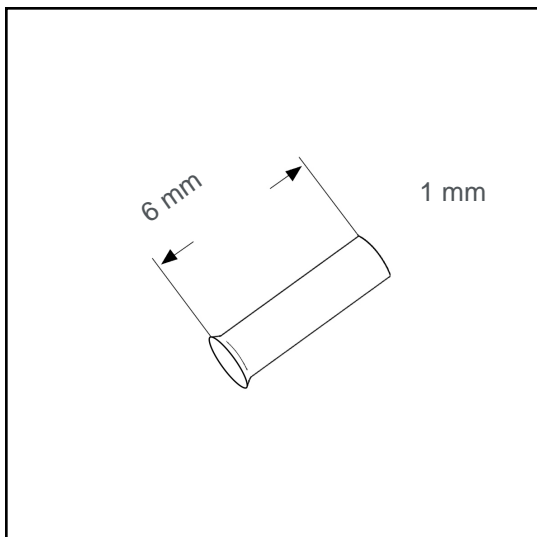

## Datasheet:

Cross section (mm <sup>2</sup> ):	1
AWG:	18
Length (mm):	6
Material:	Cu-DHP
Surface:	tin plated
Minimum thickness of tin coating:	3 µm
Max. Temp:	105°C
REACH/RoHS:	confirmed
Certificates:	UL
DIN:	DIN 46228 T1

## Packing sizes:

1000 pcs.:	Part no.: 006017
50000 pcs.:	Part no.: 005393

## Dimensions (mm):

l1	d1	s1	d2
6	1.4	0.15	2.5

