

Wire end sleeve uninsulated 0.75 mm² - 6 mm B00706

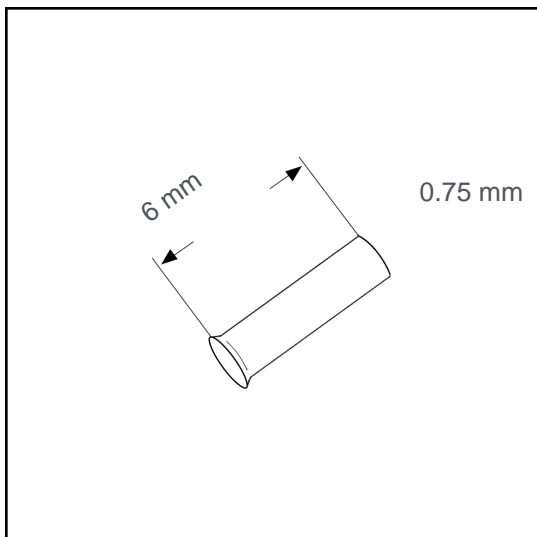

Datasheet:

Cross section (mm ²):	0.75
AWG:	18
Length (mm):	6
Material:	Cu-DHP
Surface:	tin plated
Minimum thickness of tin coating:	3 µm
Max. Temp:	105°C
REACH/RoHS:	confirmed
Certificates:	UL
DIN:	DIN 46228 T1

Packing sizes:

1000 pcs.:	Part no.: 006012
50000 pcs.:	Part no.: 005389

Dimensions (mm):

l1	d1	s1	d2
6	1.2	0.15	2.3

