

Wire end sleeve uninsulated 0.34 mm² - 7 mm B00307

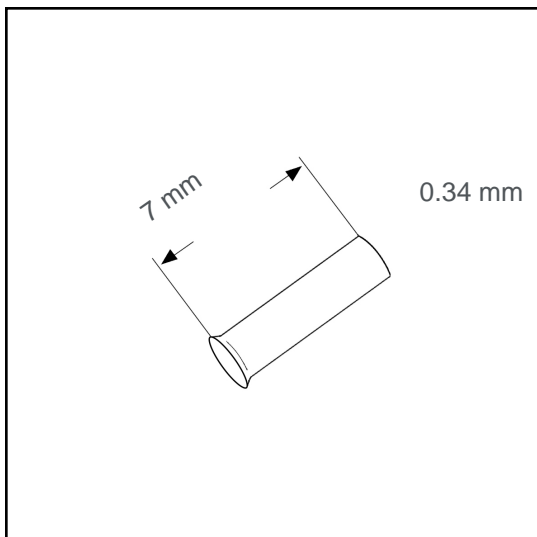

Datasheet:

Cross section (mm ²):	0.34
AWG:	22
Length (mm):	7
Material:	Cu-DHP
Surface:	tin plated
Minimum thickness of tin coating:	3 µm
Max. Temp:	105°C
REACH/RoHS:	confirmed

Packing sizes:

1000 pcs.:	Part no.: 006004
50000 pcs.:	Part no.: 005385

Dimensions (mm):

l1	d1	s1	d2
7	0.9	0.15	1.8

