

## Wire end sleeve uninsulated 0.25 mm<sup>2</sup> - 5 mm B00205

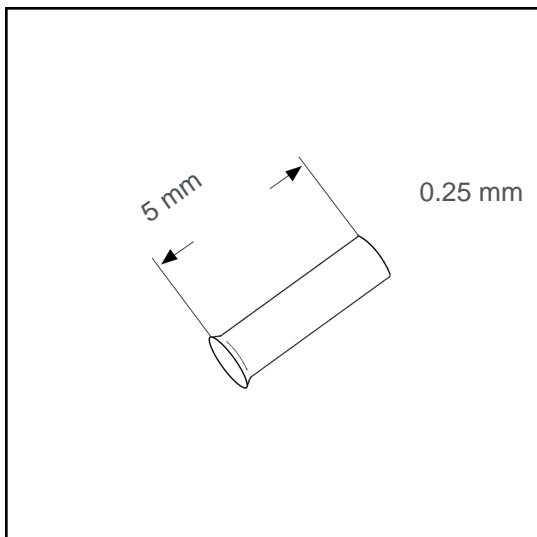

### Datasheet:

Cross section (mm <sup>2</sup> ):	0.25
AWG:	24
Length (mm):	5
Material:	Cu-DHP
Surface:	tin plated
Minimum thickness of tin coating:	3 µm
Max. Temp:	105°C
REACH/RoHS:	confirmed

### Packing sizes:

1000 pcs.:	Part no.: 006825
50000 pcs.:	Part no.: 005382

### Dimensions (mm):

l1	d1	s1	d2
5	0.8	0.15	1.7

