

Aderendhülse isoliert 50 mm² - 25 mm A50087

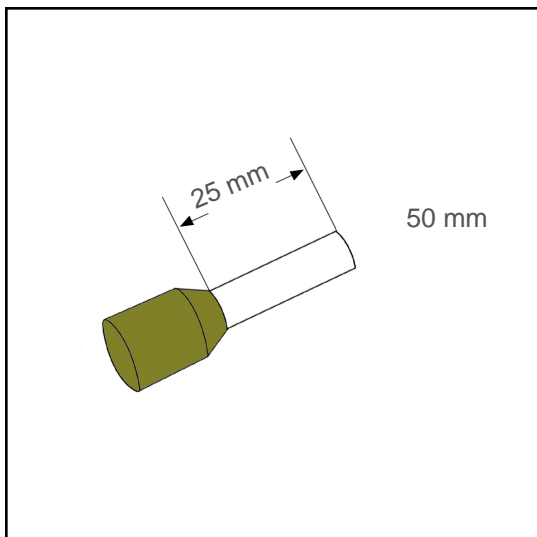

Technische Daten:

Leiterquerschnitt (mm ²):	50
AWG:	1/0
Länge (mm):	25
Farbe:	oliv
Material:	Cu-DHP / Polypropylene
Oberfläche:	verzinnt
Mindestschichtdicke der Verzinnung:	3 µm
Max. Temp:	105°C
REACH/RoHS:	konform
Zertifikate:	UL

Verpackungseinheiten:

25 St.:	Art. Nr.: 005987
2 x 25 St.:	Art. Nr.: 005986
1500 St.:	Art. Nr.: 005236

Abmessungen (mm):

l1	l2	d1	s1	d2	s2
41	25	10.5	0.3	15	0.6

