

Aderendhülse isoliert 50 mm² - 25 mm A50085

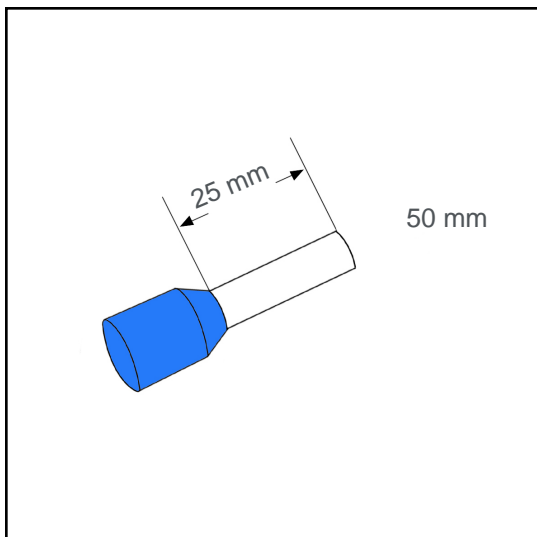

Technische Daten:

Leiterquerschnitt (mm ²):	50
AWG:	1/0
Länge (mm):	25
Farbe:	blau
Material:	Cu-DHP / Polypropylene
Oberfläche:	verzinnt
Mindestschichtdicke der Verzinnung:	3 µm
Max. Temp:	105°C
REACH/RoHS:	konform
Zertifikate:	UL
DIN:	DIN 46228 T4

Verpackungseinheiten:

25 St.:	Art. Nr.: 005985
2 x 25 St.:	Art. Nr.: 005984
1500 St.:	Art. Nr.: 005235

Abmessungen (mm):

l1	l2	d1	s1	d2	s2
41	25	10.5	0.3	15	0.6

