

Aderendhülse isoliert 25 mm² - 18 mm

A25075

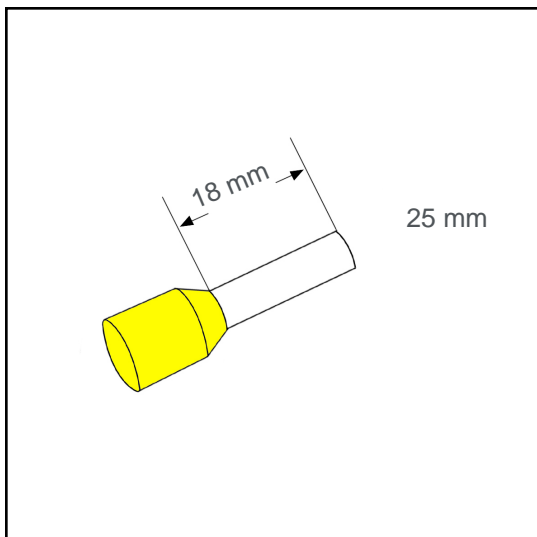

Technische Daten:

Leiterquerschnitt (mm ²):	25
AWG:	4
Länge (mm):	18
Farbe:	gelb
Material:	Cu-DHP / Polypropylene
Oberfläche:	verzinnt
Mindestschichtdicke der Verzinnung:	3 µm
Max. Temp:	105°C
REACH/RoHS:	konform
Zertifikate:	UL
DIN:	DIN 46228 T4

Verpackungseinheiten:

50 St.:	Art. Nr.: 005959
5 x 50 St.:	Art. Nr.: 005958
5000 St.:	Art. Nr.: 005222

Abmessungen (mm):

l1	l2	d1	s1	d2	s2
31	18	7.5	0.2	11.2	0.5

