

Aderendhülse isoliert 16 mm² - 12 mm A16052

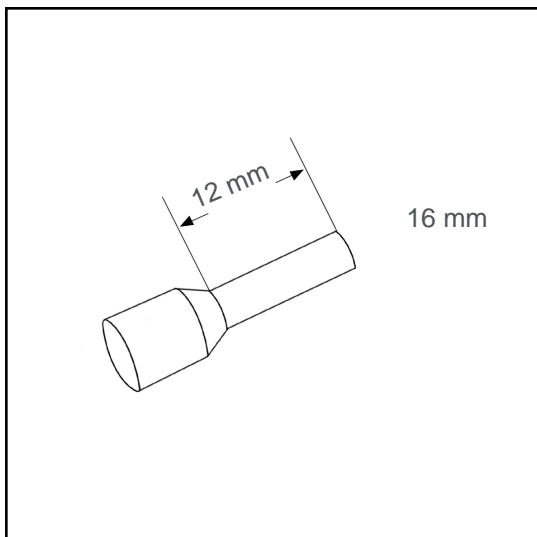

Technische Daten:

Leiterquerschnitt (mm ²):	16
AWG:	6
Länge (mm):	12
Farbe:	weiß
Material:	Cu-DHP / Polypropylene
Oberfläche:	verzinnt
Mindestschichtdicke der Verzinnung:	3 µm
Max. Temp:	105°C
REACH/RoHS:	konform
Zertifikate:	UL

Verpackungseinheiten:

100 St.:	Art. Nr.: 005918
5 x 100 St.:	Art. Nr.: 005917
8000 St.:	Art. Nr.: 005211

Abmessungen (mm):

l1	l2	d1	s1	d2	s2
23	12	6	0.2	8.8	0.4

