

Aderendhülse isoliert 10 mm² - 18 mm A10087

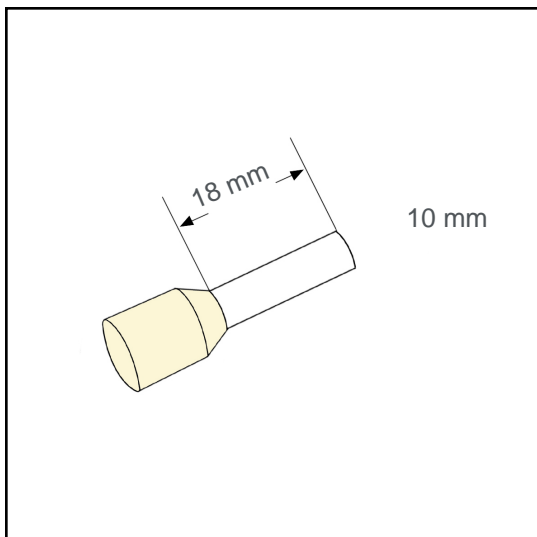

Technische Daten:

Leiterquerschnitt (mm ²):	10
AWG:	8
Länge (mm):	18
Farbe:	elfenbein
Material:	Cu-DHP / Polypropylene
Oberfläche:	verzinnt
Mindestschichtdicke der Verzinnung:	3 µm
Max. Temp:	105°C
REACH/RoHS:	konform
Zertifikate:	UL

Verpackungseinheiten:

100 St.:	Art. Nr.: 005914
10 x 100 St.:	Art. Nr.: 005913
10000 St.:	Art. Nr.: 005208

Abmessungen (mm):

l1	l2	d1	s1	d2	s2
27	18	4.6	0.2	7.6	0.3

