

Aderendhülse isoliert 6 mm² - 18 mm

A06087

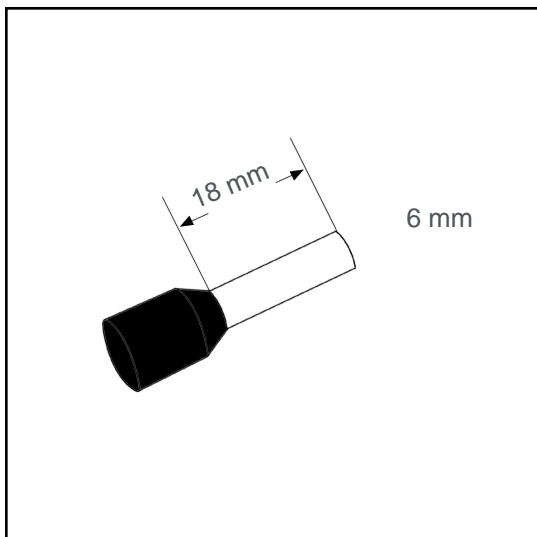

Technische Daten:

Leiterquerschnitt (mm ²):	6
AWG:	10
Länge (mm):	18
Farbe:	schwarz
Material:	Cu-DHP / Polypropylene
Oberfläche:	verzinnt
Mindestschichtdicke der Verzinnung:	3 µm
Max. Temp:	105°C
REACH/RoHS:	konform
Zertifikate:	UL

Verpackungseinheiten:

100 St.:	Art. Nr.: 005893
10 x 100 St.:	Art. Nr.: 005892
15000 St.:	Art. Nr.: 005202

Abmessungen (mm):

l1	l2	d1	s1	d2	s2
26	18	3.6	0.2	6.2	0.3

