

Aderendhülse isoliert 6 mm² - 12 mm

A06055

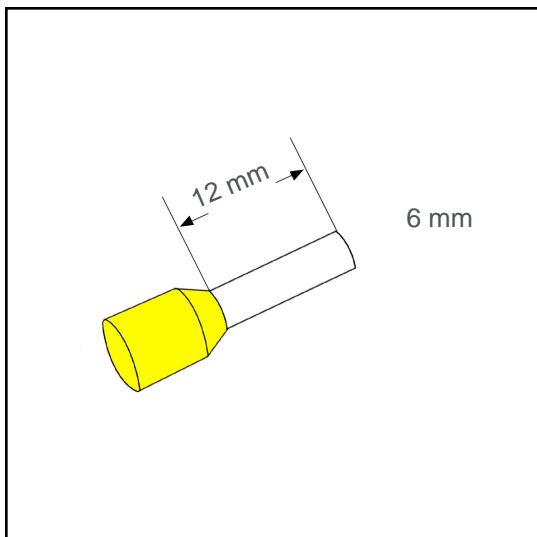

Technische Daten:

Leiterquerschnitt (mm ²):	6
AWG:	10
Länge (mm):	12
Farbe:	gelb
Material:	Cu-DHP / Polypropylene
Oberfläche:	verzinnt
Mindestschichtdicke der Verzinnung:	3 µm
Max. Temp:	105°C
REACH/RoHS:	konform
Zertifikate:	UL
DIN:	DIN 46228 T4

Verpackungseinheiten:

100 St.:	Art. Nr.: 005876
10 x 100 St.:	Art. Nr.: 005875
20000 St.:	Art. Nr.: 005198

Abmessungen (mm):

l1	l2	d1	s1	d2	s2
20	12	3.6	0.2	6.2	0.3

