

Aderendhülse isoliert 4 mm² - 18 mm

A04085

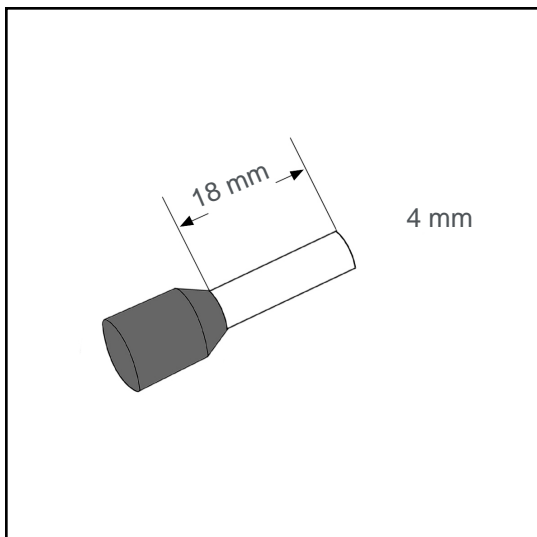

Technische Daten:

Leiterquerschnitt (mm ²):	4
AWG:	12
Länge (mm):	18
Farbe:	grau
Material:	Cu-DHP / Polypropylene
Oberfläche:	verzinnt
Mindestschichtdicke der Verzinnung:	3 µm
Max. Temp:	105°C
REACH/RoHS:	konform
Zertifikate:	UL
DIN:	DIN 46228 T4

Verpackungseinheiten:

100 St.:	Art. Nr.: 005868
10 x 100 St.:	Art. Nr.: 005867
30000 St.:	Art. Nr.: 005196

Abmessungen (mm):

l1	l2	d1	s1	d2	s2
25.5	18	2.9	0.2	4.8	0.3

