

# Aderendhülse isoliert 4 mm<sup>2</sup> - 12 mm

## A04072

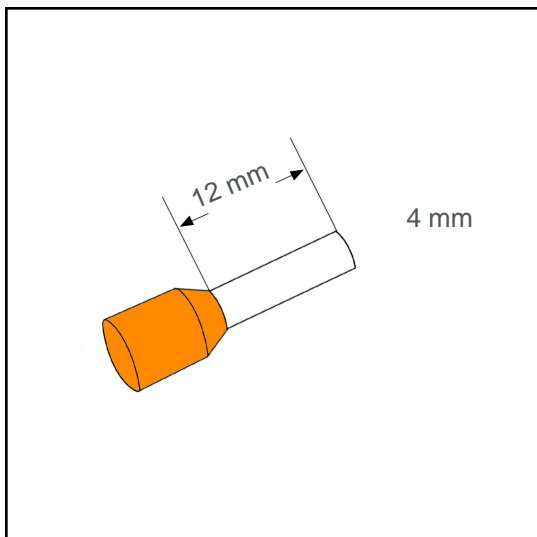

### Technische Daten:

Leiterquerschnitt (mm <sup>2</sup> ):	4
AWG:	12
Länge (mm):	12
Farbe:	orange
Material:	Cu-DHP / Polypropylene
Oberfläche:	verzinnt
Mindestschichtdicke der Verzinnung:	3 µm
Max. Temp:	105°C
REACH/RoHS:	konform
Zertifikate:	UL

### Verpackungseinheiten:

100 St.:	Art. Nr.: 005860
10 x 100 St.:	Art. Nr.: 005859
30000 St.:	Art. Nr.: 005193

### Abmessungen (mm):

l1	l2	d1	s1	d2	s2
19.5	12	2.9	0.2	4.8	0.3

