

Aderendhülse isoliert 2.5 mm² - 8 mm

A02555

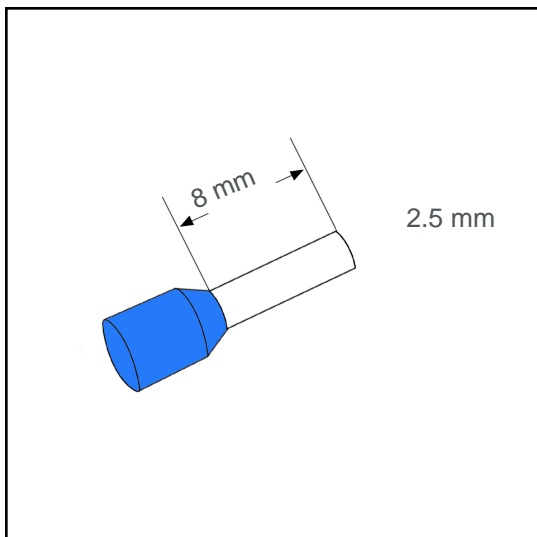

Technische Daten:

Leiterquerschnitt (mm ²):	2.5
AWG:	14
Länge (mm):	8
Farbe:	blau
Material:	Cu-DHP / Polypropylene
Oberfläche:	verzinnt
Mindestschichtdicke der Verzinnung:	3 µm
Max. Temp:	105°C
REACH/RoHS:	konform
Zertifikate:	UL
DIN:	DIN 46228 T4

Verpackungseinheiten:

500 St.:	Art. Nr.: 005819
10 x 100 St.:	Art. Nr.: 005818
50000 St.:	Art. Nr.: 005184

Abmessungen (mm):

l1	l2	d1	s1	d2	s2
15	8	2.3	0.15	4.1	0.3

