

Aderendhülse isoliert 1.5 mm² - 18 mm

A01585

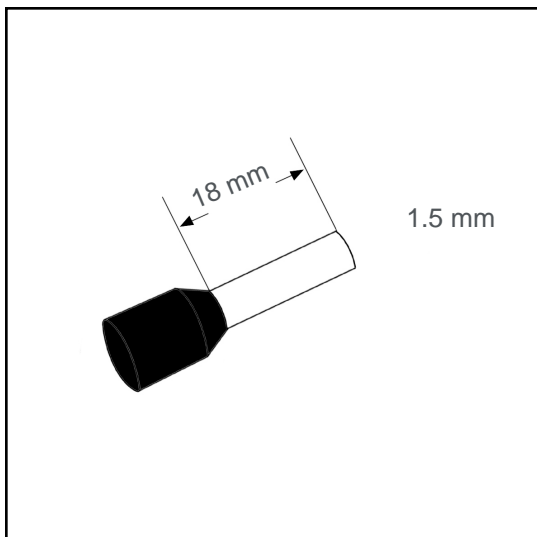

Technische Daten:

Leiterquerschnitt (mm ²):	1.5
AWG:	16
Länge (mm):	18
Farbe:	schwarz
Material:	Cu-DHP / Polypropylene
Oberfläche:	verzinnt
Mindestschichtdicke der Verzinnung:	3 µm
Max. Temp:	105°C
REACH/RoHS:	konform
Zertifikate:	UL
DIN:	DIN 46228 T4

Verpackungseinheiten:

500 St.:	Art. Nr.: 005802
10 x 100 St.:	Art. Nr.: 005801
50000 St.:	Art. Nr.: 005180

Abmessungen (mm):

l1	l2	d1	s1	d2	s2
24.5	18	1.73	0.15	3.4	0.3

