

Aderendhülse isoliert 1.5 mm² - 8 mm

A01555

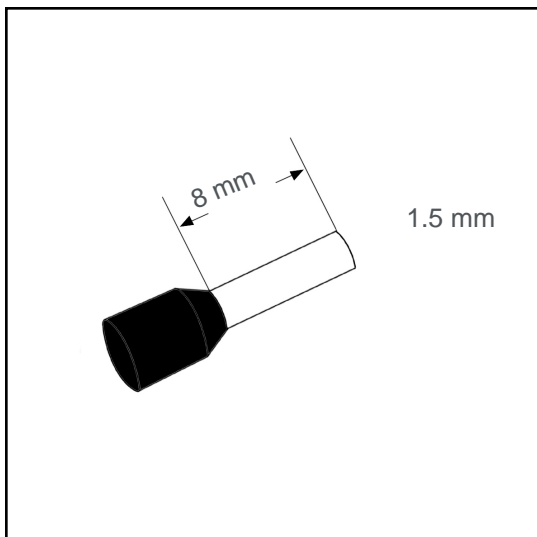

Technische Daten:

Leiterquerschnitt (mm ²):	1.5
AWG:	16
Länge (mm):	8
Farbe:	schwarz
Material:	Cu-DHP / Polypropylene
Oberfläche:	verzinnt
Mindestschichtdicke der Verzinnung:	3 µm
Max. Temp:	105°C
REACH/RoHS:	konform
Zertifikate:	UL
DIN:	DIN 46228 T4

Verpackungseinheiten:

500 St.:	Art. Nr.: 005763
10 x 100 St.:	Art. Nr.: 005762
50000 St.:	Art. Nr.: 005174

Abmessungen (mm):

l1	l2	d1	s1	d2	s2
14.5	8	1.73	0.15	3.4	0.3

