

Aderendhülse isoliert 0.5 mm² - 8 mm

A00557

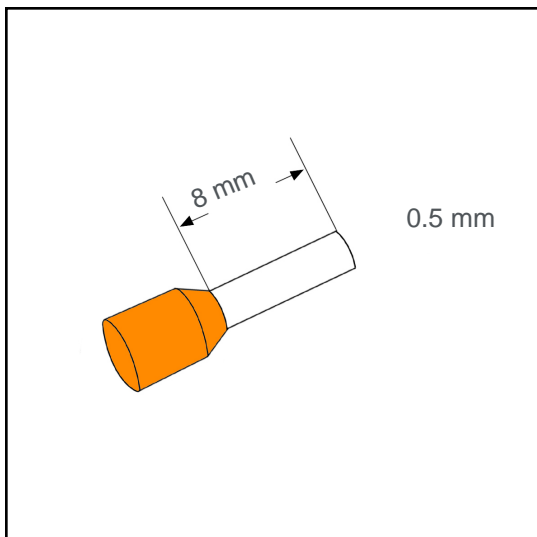

Technische Daten:

Leiterquerschnitt (mm ²):	0.5
AWG:	20
Länge (mm):	8
Farbe:	orange
Material:	Cu-DHP / Polypropylene
Oberfläche:	verzinnt
Mindestschichtdicke der Verzinnung:	3 µm
Max. Temp:	105°C
REACH/RoHS:	konform
Zertifikate:	UL

Verpackungseinheiten:

500 St.:	Art. Nr.: 005617
10 x 100 St.:	Art. Nr.: 005616
50000 St.:	Art. Nr.: 005149

Abmessungen (mm):

l1	l2	d1	s1	d2	s2
14	8	1.1	0.15	2.4	0.3

