

# Aderendhülse isoliert 0.5 mm<sup>2</sup> - 8 mm

## A00555

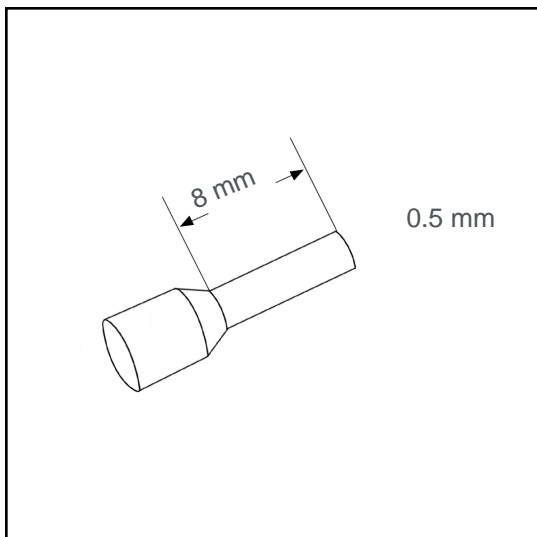

### Technische Daten:

Leiterquerschnitt (mm <sup>2</sup> ):	0.5
AWG:	20
Länge (mm):	8
Farbe:	weiß
Material:	Cu-DHP / Polypropylene
Oberfläche:	verzinnt
Mindestschichtdicke der Verzinnung:	3 µm
Max. Temp:	105°C
REACH/RoHS:	konform
Zertifikate:	UL
DIN:	DIN 46228 T4

### Verpackungseinheiten:

500 St.:	Art. Nr.: 005607
10 x 100 St.:	Art. Nr.: 005606
50000 St.:	Art. Nr.: 005148

### Abmessungen (mm):

l1	l2	d1	s1	d2	s2
14	8	1.1	0.15	2.4	0.3

