

Aderendhülse isoliert 0.25 mm² - 8 mm

A00285

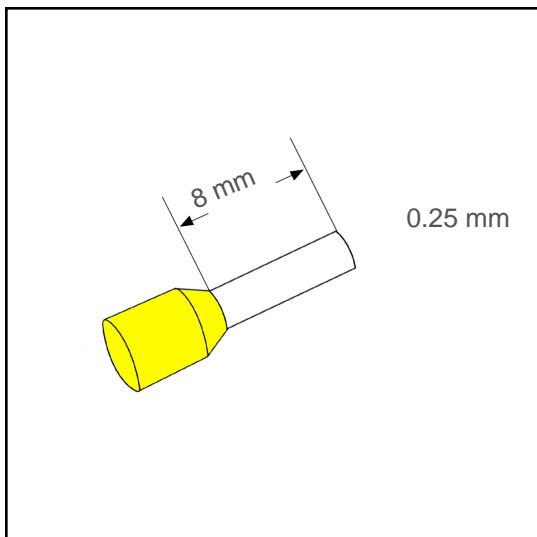

Technische Daten:

Leiterquerschnitt (mm ²):	0.25
AWG:	24
Länge (mm):	8
Farbe:	gelb
Material:	Cu-DHP / Polypropylene
Oberfläche:	verzinnt
Mindestschichtdicke der Verzinnung:	3 µm
Max. Temp:	105°C
REACH/RoHS:	konform
Zertifikate:	UL
DIN:	DIN 46228 T4

Verpackungseinheiten:

500 St.:	Art. Nr.: 005570
10 x 100 St.:	Art. Nr.: 005569
50000 St.:	Art. Nr.: 004984

Abmessungen (mm):

l1	l2	d1	s1	d2	s2
12.5	8	0.8	0.15	1.9	0.3

