

Wire end sleeve coils 0.5 mm² - 10 mm

A00575B

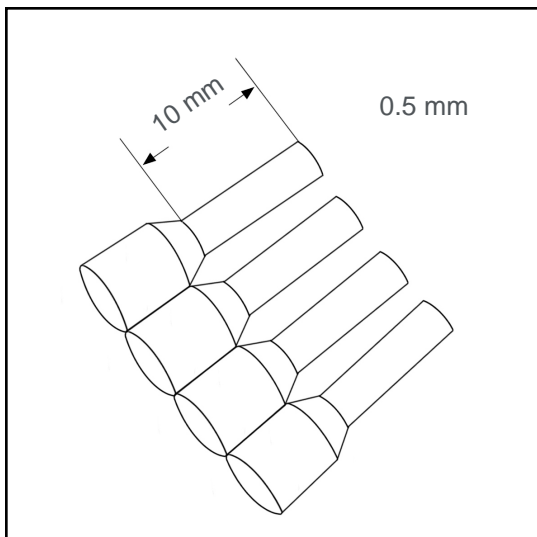

Datasheet:

Cross section (mm ²):	0.5
AWG:	20
Length (mm):	10
Color:	white
Material:	Cu-DHP / Polypropylene
Surface:	tin plated
Minimum thickness of tin coating:	3 μm
Max. Temp:	105°C
REACH/RoHS:	confirmed

Packing sizes:

3000 pcs.: Part no.: 010906

Dimensions (mm):

l1	l2	d1	s1	d2	s2	r
16.5	10	1.1	0.15	2.6	0.4	3.5

